

Data sheet | Item number: 221-683

COMPACT Splicing Connector; for all conductor types; for Ex e applications;
max. 6 mm²; 3-conductor; with levers; transparent housing; Operating
temperature (max.): 105 °C; 6,00 mm²; transparent

www.wago.com/221-683



RoHS
Compliant

✓
BOMcheck.net

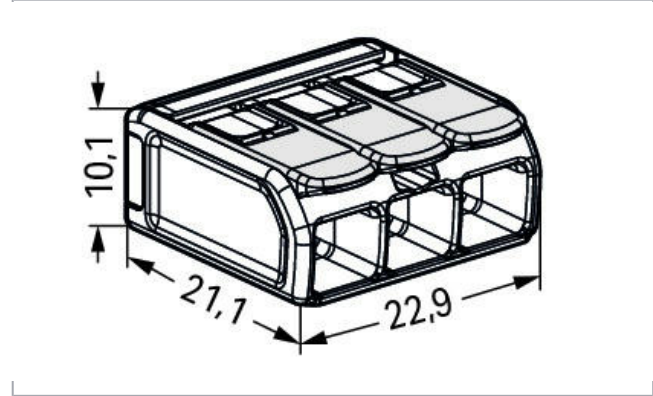

Item description

Your Benefits:

- Ease of use – pull the lever up, insert a conductor and push the lever back down
- Available as 2-, 3- and 5-wire connectors
- Easily terminate conductors from 0.5 to 6 mm²
- Connection of all conductor types
- Time savings for installers and device manufacturers
- Quickly install devices with higher levels of power consumption
- Safely install long cable runs with larger conductor cross sections
- Mounting carrier for installation conforms to standards
- Working voltages of 275 V or 440 V
- Custom carriers are possible
- ATEX (Ex 2 II G), IECEx (Ex eb IIC Gb) Zone 1, 2
- IECEx (Ex eb IIC Gb), American Ex (AEx eb IICGb) / Class 1, Zone 1

Safety information 1:

The permissible operating voltage of the connector with carrier (440 V or 275 V) depends on the mounting type.

Safety information 2:

Only approved in conjunction with a mounting carrier (221-511). Other carriers are possible, see certificate/file.

Subject to changes. Please also observe the further product documentation!

WAGO Corporation
Germantown, WI 53022
Phone: 1-800-DIN-RAIL (346-7245) | Fax: (262) 255-6222
Email: info.us@wago.com | Web: www.wago.us

Do you have any questions about our products?
We are always happy to take your call at {0}.



The connectors must be installed in an enclosure meeting the requirements of a recognized protection type per EN 60079-0, Section 1 or EN 60079-31.

When installing the connectors in an enclosure of protection type "eb" (increased safety) per EN 60079-7, the clearances and creepage distances of Table 2 for this standard must be observed. See point 1 for the use of accessories. The connectors can be used both in Group II and Group I, as the standard requirements are identical in this case.

The use of these components requires a new assessment by a notified certification agency.

Data

Electrical data

Ratings per IEC/EN 60664-1

Ratings per	EN 60664
-------------	----------

Ratings per UL 1059

Approvals per	UL 60079
Rated voltage UL (Use Group C)	440 V
Rated current UL (Use Group C)	30 A

Ex information

Ratings per	ATEX: PTB 19 ATEX 1001 U / IECEx: PTB 19.001 1U (Ex eb IIC Gb)
Rated voltage EN (Ex e II)	440 V
Rated current (Ex e II)	37 A

Connection data

Connection technology	CAGE CLAMP®
Actuation type	Lever
Connectable conductor materials	Copper
Nominal cross-section	6 mm ²
Solid conductor	0.5 ... 6 mm ² / 20 ... 10 AWG
Stranded conductor	0.5 ... 6 mm ² / 20 ... 10 AWG
Fine-stranded conductor	0.5 ... 6 mm ² / 20 ... 10 AWG
Strip length	12 ... 14 mm / 0.47 ... 0.55 inch
Total number of connection points	3
Total number of potentials	1
Wiring type	Side-entry wiring

Subject to changes. Please also observe the further product documentation!

WAGO Corporation
 Germantown, WI 53022
 Phone: 1-800-DIN-RAIL (346-7245) | Fax: (262) 255-6222
 Email: info.us@wago.com | Web: www.wago.us

Do you have any questions about our products?
 We are always happy to take your call at {0}.

Physical data

Width	22.9 mm / 0.902 inch
Height	10.1 mm / 0.398 inch
Depth	21.1 mm / 0.831 inch

Material data

Color	transparent
Flammability class per UL94	V2
Fire load	0.08 MJ
Color of actuator	light gray
Weight	4.3 g

Environmental requirements



Continuous operating temperature	105 °C
----------------------------------	--------

Commercial data

Packaging type	BOX
Country of origin	CH
GTIN	4055143860574
Customs tariff number	85369010000

Approvals / Certificates

Ex-Approvals

Logo	Approval	Additional Approval Text	Certificate name
	AEx Underwriters Laboratories Inc.	UL 60079	20190228-E185892
	ATEX Physikalisch Technische Bundesanstalt	IEC 60079-0	PTB 19 ATEX 1001 U
	CCCEX CQST/CNEx	CNCA-C23-01	2020312313000185
	IECEX	IEC 60079-0	IECEX PTB 19.001

Subject to changes. Please also observe the further product documentation!



Country specific Approvals



Logo	Approval	Additional Approval Text	Certificate name
	KEMA/KEUR DEKRA Certification B.V.	EN 60998	71- 105677

Ship Approvals

Logo	Approval	Additional Approval Text	Certificate name
	LR Lloyds Register	EN 60998	04/20013 (E8)

Compatible products

Mounting adapter

	Item no.: 221-510/000-006 Mounting carrier; 221 series (20 - 10 AWG); for DIN-35 rail/panel mount; blue	www.wago.com/221-510/000-006
	Item no.: 221-511 Mounting carrier; for Ex applications; 221 Series - 6 mm ² ; for DIN-35 rail mounting/screw mounting; light gray	www.wago.com/221-511

Downloads

Documentation

Additional Information

Technical explanations	2019-4-3	pdf 2.2 MB	Download
------------------------	----------	---------------	----------

CAD files

CAD data

2D/3D Models 221-683	URL	Download
----------------------	-----	----------

Subject to changes. Please also observe the further product documentation!

CAE data

ZUKEN Portal 221-683

URL

Download

Installation Notes

Conductor termination

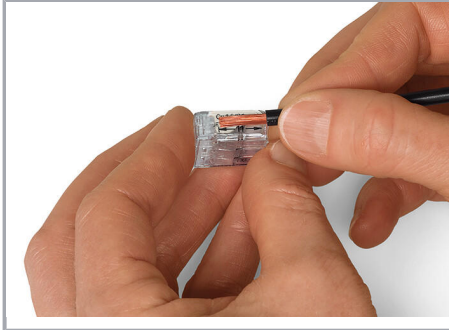

Strip conductor to 11 mm (0.43 inch).

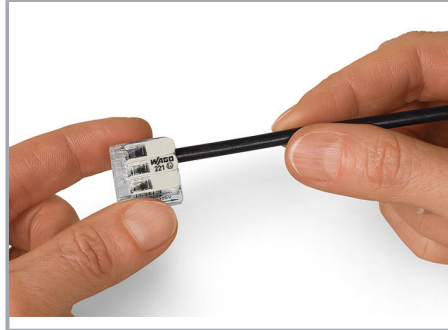

Then, lower the lever to close the clamp.

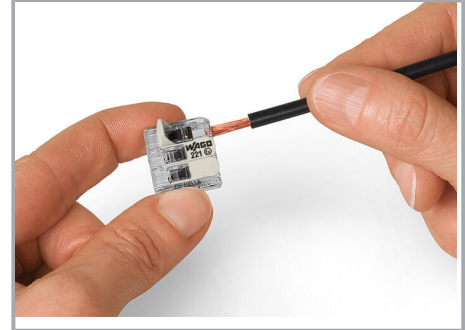

Termination: Lift the lever to open the clamping unit and insert a stripped conductor.

Installation

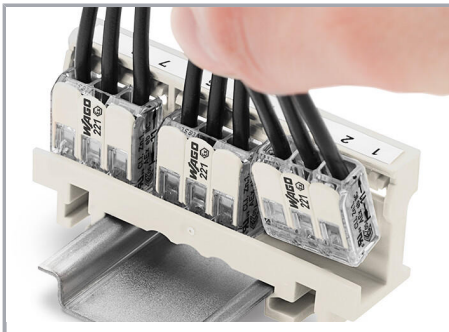

Inserting a connector into the mounting carrier.

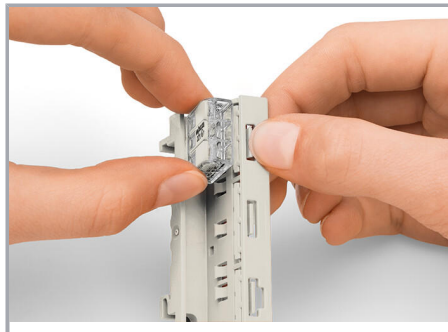

Removing a connector from the mounting carrier.

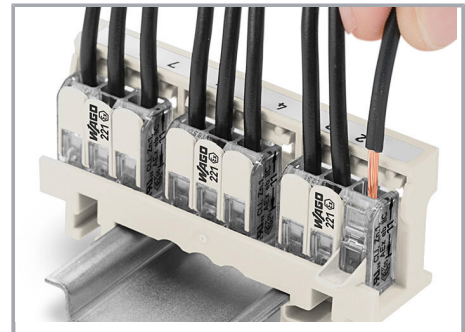

Removing a conductor.

Subject to changes. Please also observe the further product documentation!

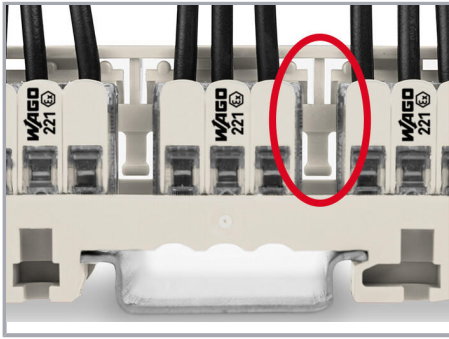

Mounting type (440 V)
Using spacers between the connectors.

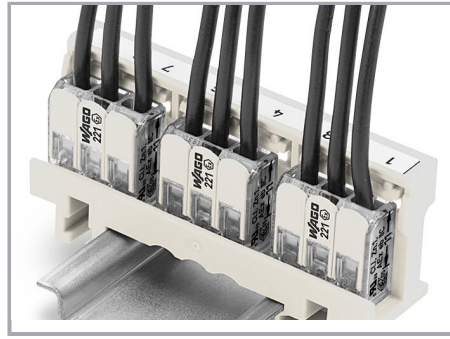

Mounting type (440 V)
Vertical mounting on DIN-35 rail

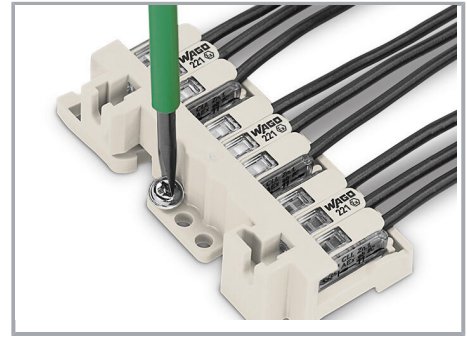

Mounting type (440 V)
Horizontal screw mounting on a flat surface

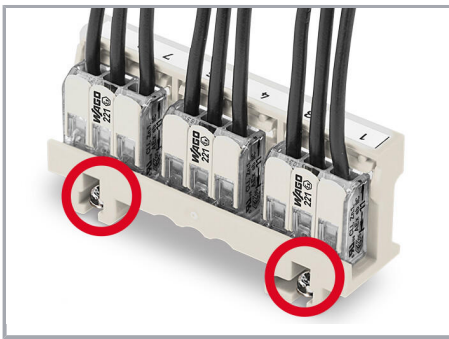

Mounting type (440 V)
Mounting the carrier via non-conductive screws.

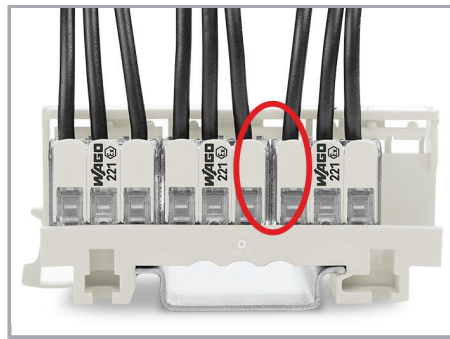

Mounting type (275 V)
No spacers are used between the connectors.

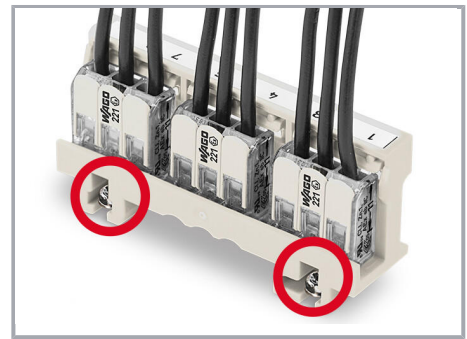

Mounting type (275 V)
Mounting the carrier using conductive screws.

Testing

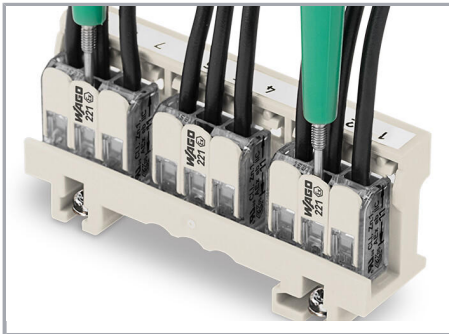

Easily test inserted connectors in the carrier
– without considering the type of mounting.

Subject to changes. Please also observe the further product documentation!